

| 일반 행거 설치 가이드 |

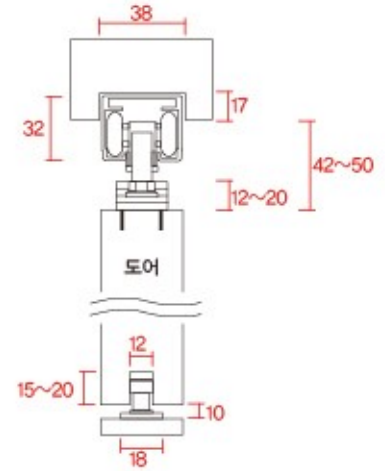

1 상부롤러 삽입

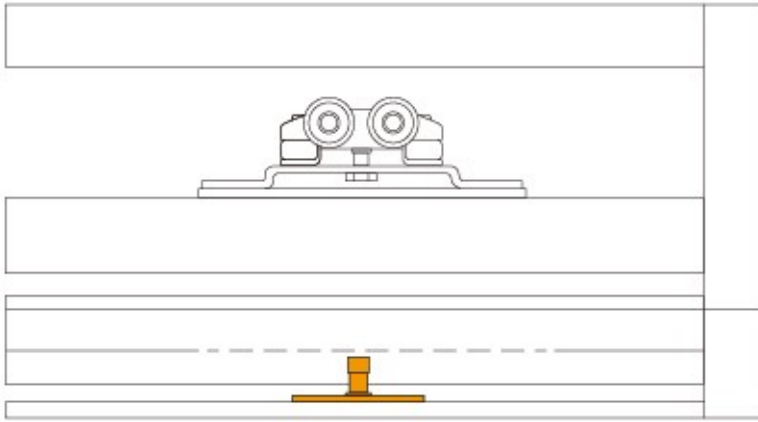
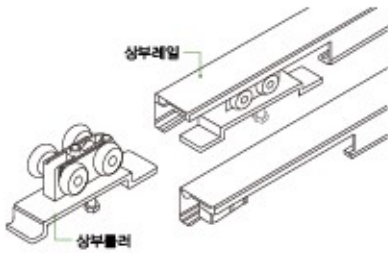

2 상부레일 및 하부롤러 설치

\* 하부가이드 설치 시, 하부 홈꽃이 중앙을 꼭 맞추기 바랍니다.

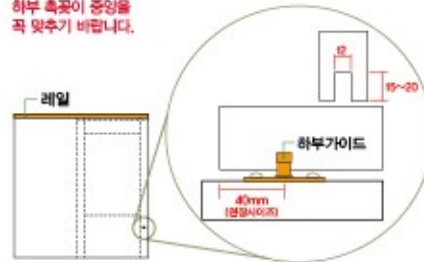

3 도어고정판 부착

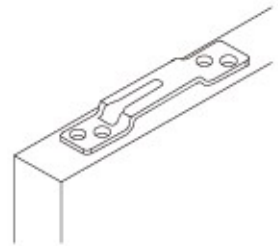

4 도어설치

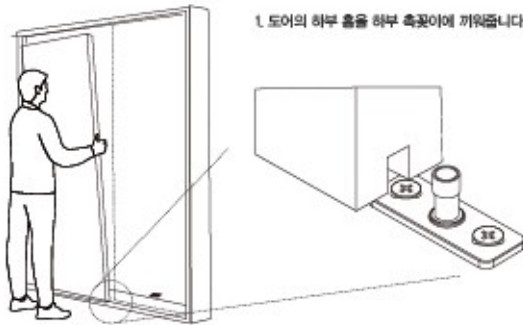

2. 상부롤러를 도어고정판 홈에 삽입합니다.

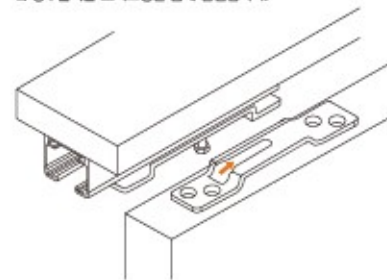

5 수평/높이 조절

스패너를 이용하여 상부롤러의 하단에 부착된 높이조정볼드로 사용높이를 조정하고 수평을 맞춥니다.

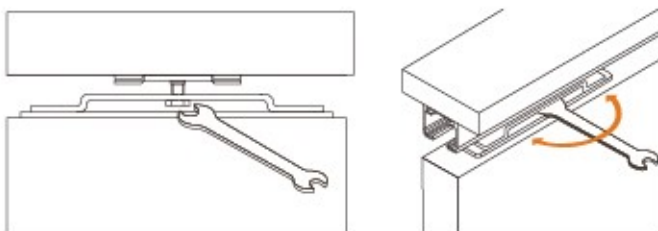

6 스톱퍼 고정

스톱퍼를 조정하여 설치를 마무리 합니다.

